

TOTOLINK
The Smartest Network Device

Quick Installation Guide

AX3000 Dual Band Wireless Gigabit Router

Model No: X6000R

Copyrights © TOTOLINK. All Rights Reserved. Website: <http://www.totolink.net>
Information in this document is subject to change without prior notice.

1 Installation Diagram

(1) Default Wi-Fi Name (SSIDs):
2.4G: TOTOLINK_X6000R
5G: TOTOLINK_X6000R_5G

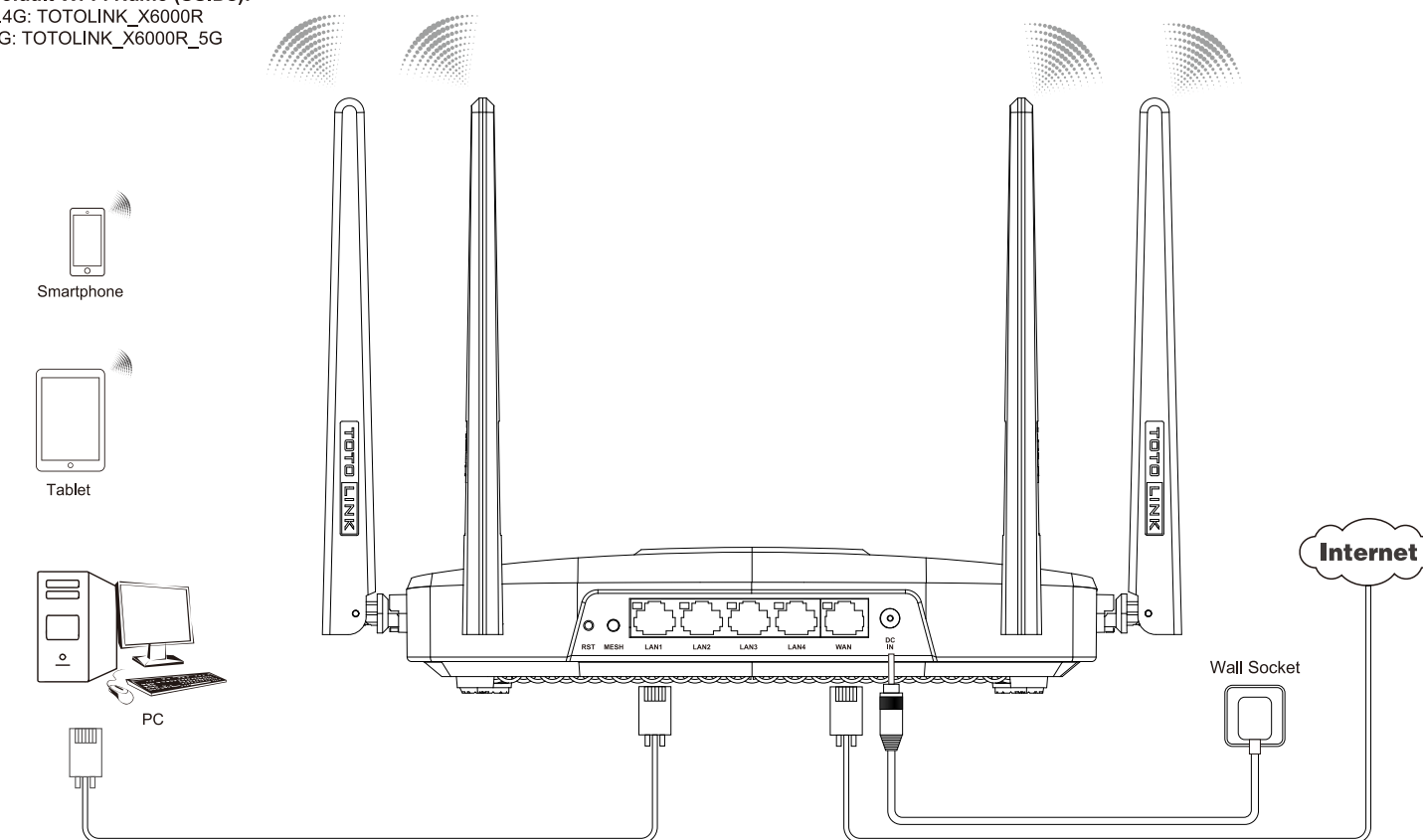

(2) LED Indicators:

Indicators	Status	Description
System indicator	On	The router is booting/MESH pairing network
	Off	The router is not connecting to the power
	Blinking slowly	The router is working normally
	Blinking quickly	Restore to default setting
WAN/LAN 1-4 indicators	On	The port is connected
	Off	The port is disconnected
	Blinking	The port is transmitting data

(3) Ports/Button

Ports/Button	Description
Power port	Connected to power adaptor
LAN1-LAN4 Port	Connect to PC and other devices
WAN Port	Connect to Internet
MESH Button	Press 1-3 seconds until System indicator is on to enable MESH function.
RST button	Press 5 seconds until System indicator blinking quickly, restore to default setting

2 Configure the Router on Phone

1 Activate the WLAN function on your Phone and connect to TOTOLINK_X6000R_5G or TOTOLINK_X6000R. Then run any Web browser and enter <http://totolink.net> in the address bar.(P1)

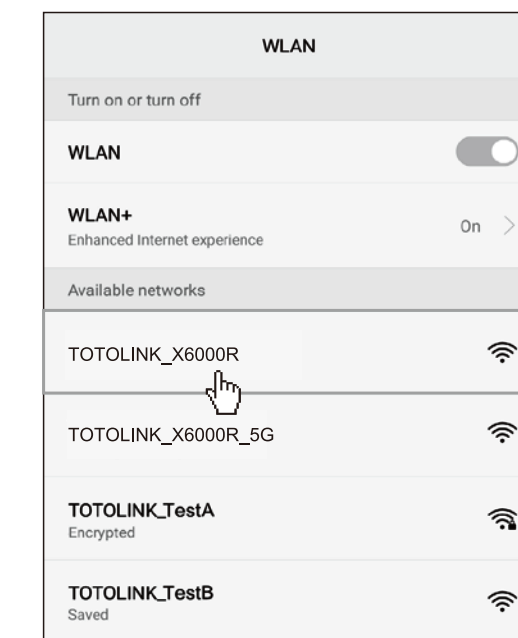

(P1)

2 Enter **admin** for the password and then click **LOGIN**.(P2)

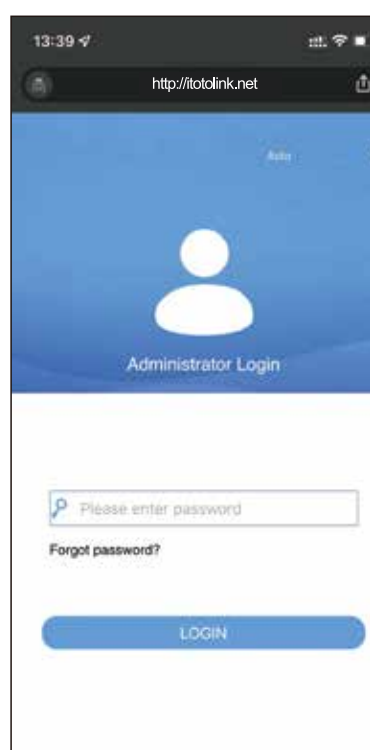

(P2)

3 Click **Quick Setup** on the coming page.(P3)



(P3)

4 Time Zone Setting. According to your location, please select a suitable option from the list, then click **Next**.(P4)



(P4)

5 Internet Setting. Choose a suitable connection type from the list and fill in the information required, then click **Next**.(P5-P6)

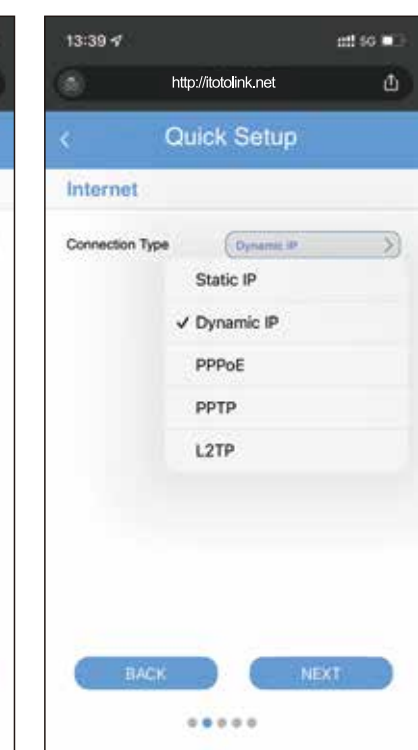

(P5)

6 Wireless Setting. Create passwords for 2.4G Wi-Fi and 5G Wi-Fi (Here users could also revise the default Wi-Fi name) and then click **Next**.(P7)

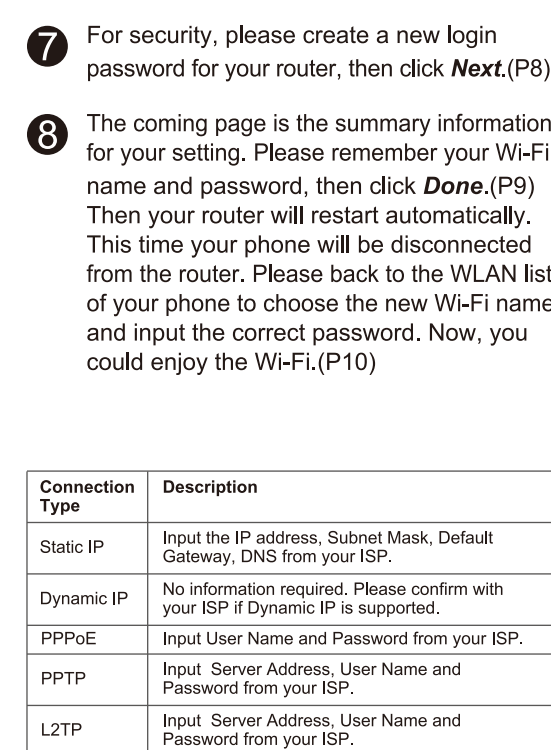

(P6)



(P7)

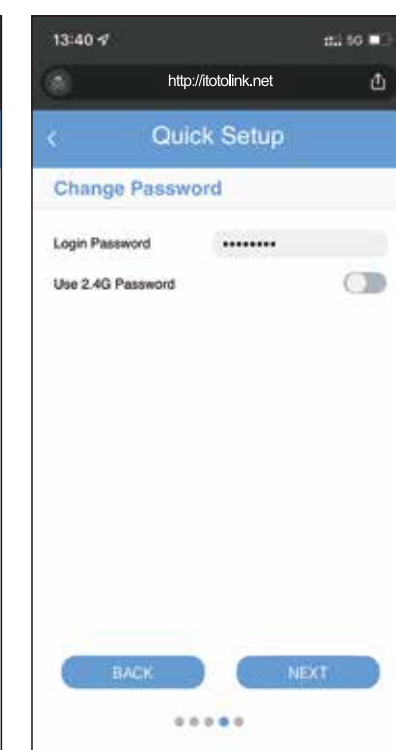

(P8)



(P9)

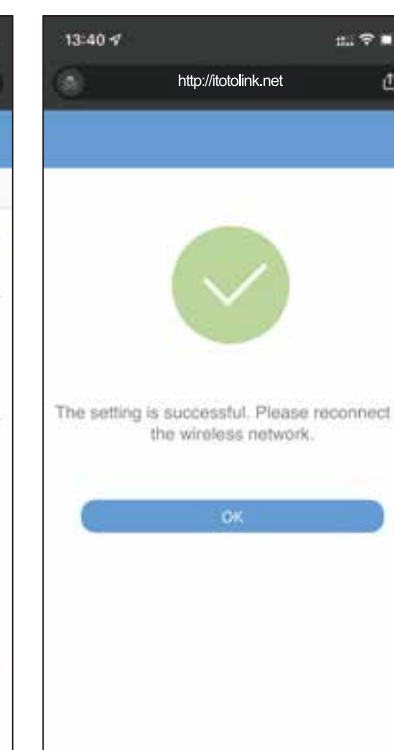

(P10)

Connection Type	Description
Static IP	Input the IP address, Subnet Mask, Default Gateway, DNS from your ISP.
Dynamic IP	No information required. Please confirm with your ISP if Dynamic IP is supported.
PPPoE	Input User Name and Password from your ISP.
PPTP	Input Server Address, User Name and Password from your ISP.
L2TP	Input Server Address, User Name and Password from your ISP.

3 EasyMesh Networking Function

X6000R router has EasyMesh networking function. With the advanced EasyMesh networking function, the network units work together to form a unified network with a single network name. When you move around the house, the device will automatically switch between the two to get the fastest possible speed. The specific operation steps of networking function setting are as follows.

1 Installation Diagram

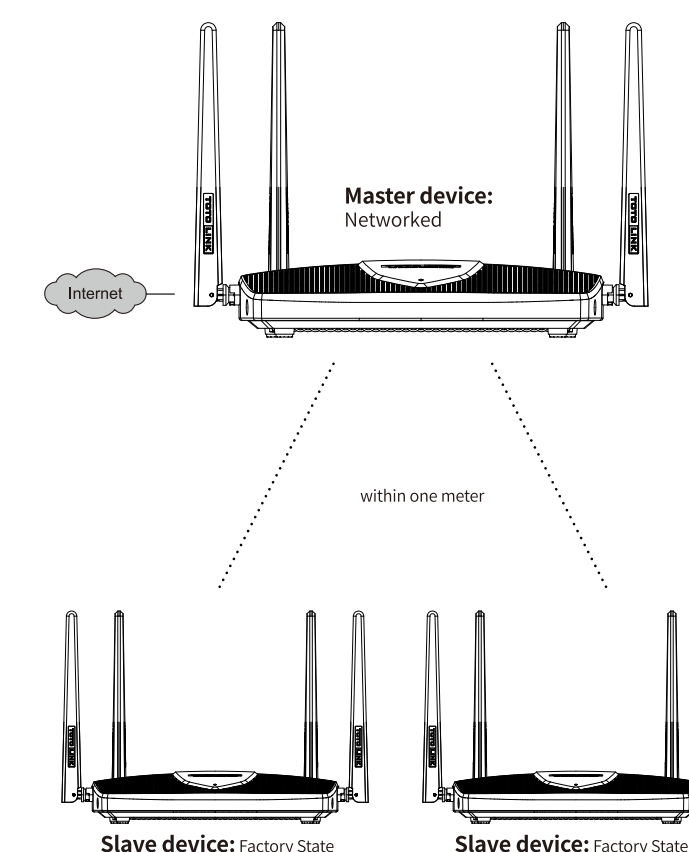

2 Build the Master Device Environment

(1) First, after ensuring that the master device is networked, connect the PC to the X6000R's LAN port with a network cable. Then open any web browser, enter <http://totolink.net> in the address bar, and log in to the web management interface of the master device. Last select **EasyMesh** settings interface, open the **Mesh Settings**, select the **Controller Mode** and click "Apply". Waiting for setting.

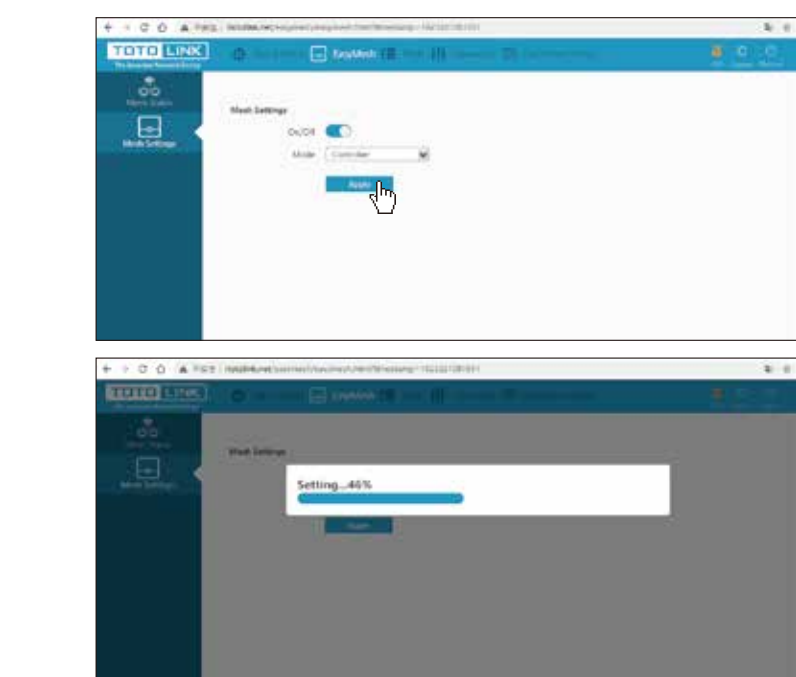

(2) On the "controller mode" page, you can set the **Basic Service Setup**, and click "Apply" after the setting is complete. Waiting for setting.

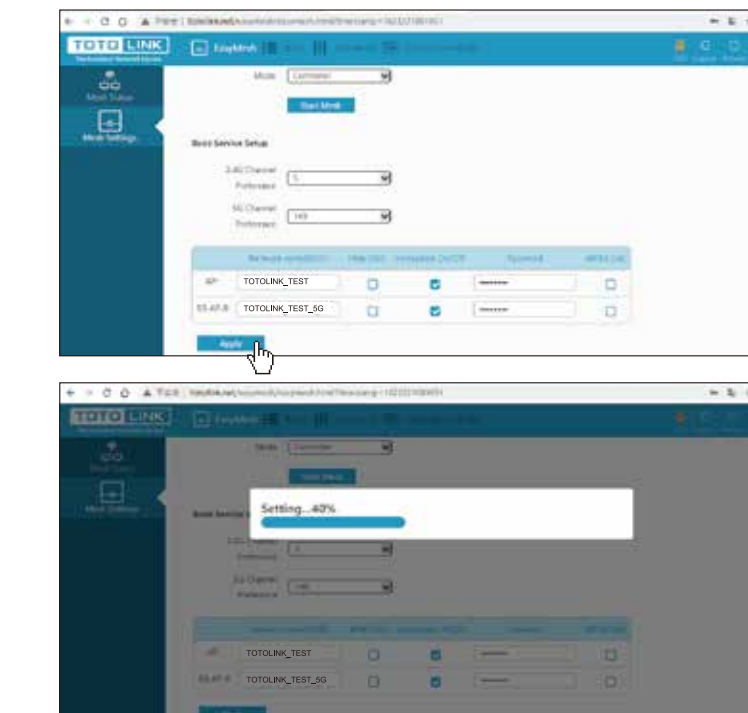

3 Build the Slave Device Environment

(1) Make sure that another X6000R is powered on, the LAN port is connected to the PC. And open the web browser enter the setting page of <http://totolink.net>. Then select the **EasyMesh** setting interface, open the **Mesh settings**, select the **Agent Mode** and clicks "Apply". Waiting for setting.

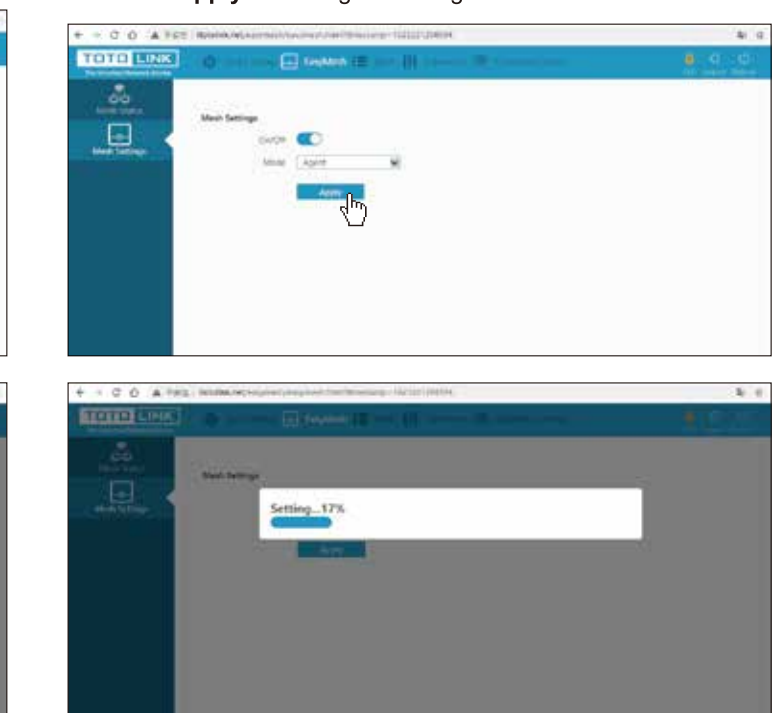

2 Enter **admin** for the password and then click **LOGIN**.(P2)

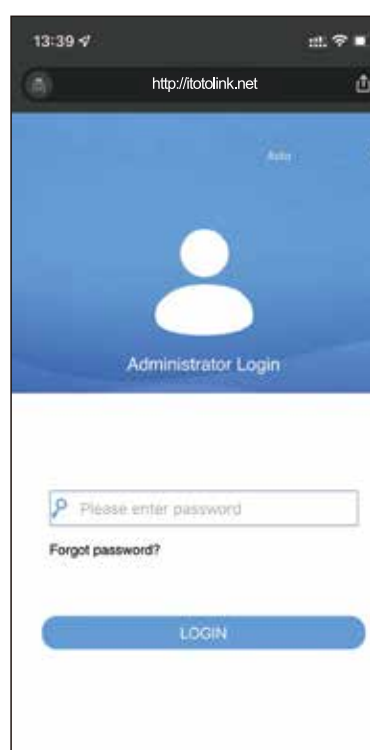

(P2)

3 Click **Quick Setup** on the coming page.(P3)



(P3)

4 Time Zone Setting. According to your location, please select a suitable option from the list, then click **Next**.(P4)



(P4)

5 Internet Setting. Choose a suitable connection type from the list and fill in the information required, then click **Next**.(P5-P6)

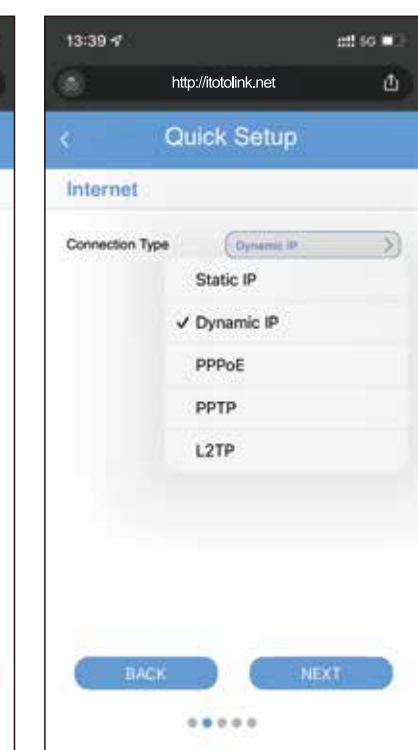

(P5)

6 Wireless Setting. Create passwords for 2.4G Wi-Fi and 5G Wi-Fi (Here users could also revise the default Wi-Fi name) and then click **Next**.(P7)

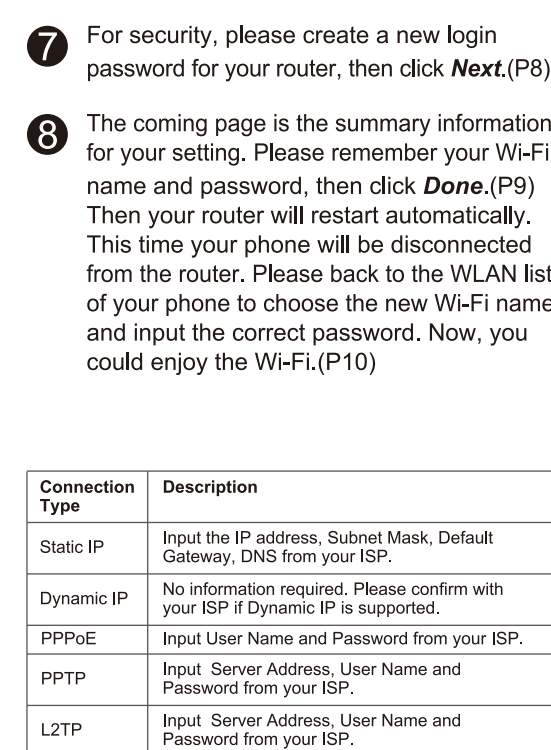

(P6)



(P7)

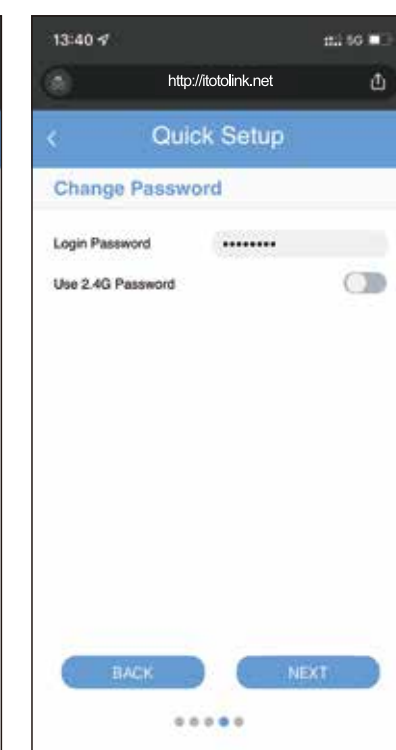

(P8)



(P9)

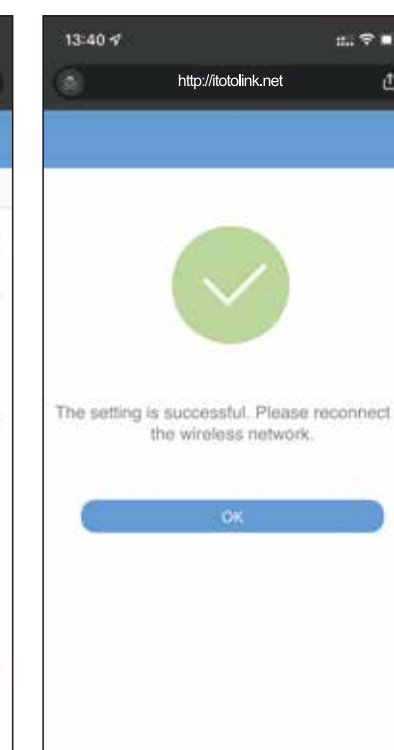

(P10)

Connection Type	Description
Static IP	Input the IP address, Subnet Mask, Default Gateway, DNS from your ISP.
Dynamic IP	No information required. Please confirm with your ISP if Dynamic IP is supported.
PPPoE	Input User Name and Password from your ISP.
PPTP	Input Server Address, User Name and Password from your ISP.
L2TP	Input Server Address, User Name and Password from your ISP.

(2) On the "agent mode" page, you can set the **Basic Service Setup**, and click "Apply" after the setting is complete. Waiting for setting.

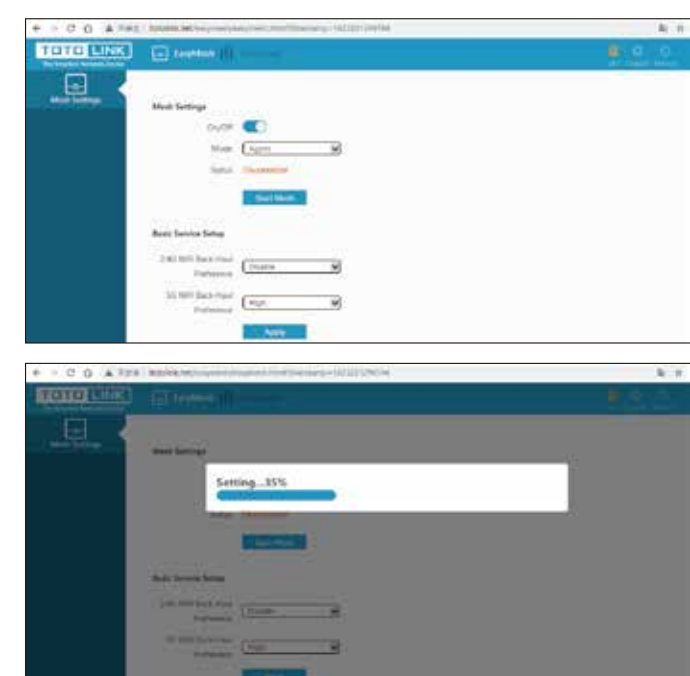

4 EasyMesh Networking Pairing

(1) Make sure that the master device is successfully connected to the network, press and hold the "MESH" button of the master device and the slave device at the same time for about 1-3 seconds. Then release your hand, the indicator light of two routers will always be on and enter the networking state. (Required waiting for about 30 seconds.) Note: Press the "MESH" button for no more than 3 seconds, usually 1-2 seconds.

(2) After the mesh connection is successful, use the PC browser to enter <http://totolink.net> and click "EasyMesh"- "Mesh Status" to view the status of the mesh connection.



(3) If the third X6000R joins the EasyMesh network, for the connected slave device, follow the third step again to set up the slave device environment. Then simultaneously press and hold the MESH button of the master and slave device for 1-3 seconds to continue sending the networking request. During the trigger period, a new network will be added after the response is received. (Required waiting for 2 minutes.)

4 FAQs

1. Unable to log in the router's web page on Phone?

Please check if your Phone has connected to the Wi-Fi of the router and make sure you have entered the correct default gateway <http://totolink.net>.

2. If I forget the router's login password, how to reset to the factory settings?

Keep the router powered on, then press and hold the RST button for 5-8 seconds until system indicator becomes blinking quickly. The router will restart automatically, wait for a while, the password would be resumed to admin.

3. After the slave device is powered off, do I need to reorganize the network?

No, just turn on the power again.

4. If I want to add a new slave device to the existing Wi-Fi networking system, do I need to reorganize the network for all routers?

No, as long as the slave device is within 1 meter of the Wi-Fi of the master device, and connected to the power. Then the slave device environment can be set up according to the manual of EasyMesh Networking Function introduction.

5. Why is my EasyMesh network unsuccessful all the time?

First: Must be matched within 1 meter of the master device.
Next: The master device needs to set up the Internet according to the following two conditions: (1) This device may not cause harmful interference, and (2) this device must accept any interference received, including interference that may cause undesired operation.
Finally: The software version is unified to the latest version, please go to TOTOLINK official website to download: www.totolink.cn.

6. Why is there no wireless setting in the advanced settings after EasyMesh is turned on?

This function can be set on the EasyMesh page.

FCC Statement

This equipment has been tested and found to comply with the limits for a Class B digital device, pursuant to part 15 of the FCC Rules. These limits are designed to provide reasonable protection against harmful interference in a residential installation. This equipment generates, uses and can radiate radio frequency energy and, if not installed and used in accordance with the instructions, may cause harmful interference to radio communications. However, there is no guarantee that interference will not occur in a particular installation. If this equipment does cause harmful interference to radio or television reception, which can be determined by turning the equipment off

and on, the user is encouraged to try to correct the interference by one or more of the following measures:

- Reorient or relocate the receiving antenna.
 - Increase the separation between the equipment and receiver.
 - Connect the equipment into an outlet on a circuit different from that to which the receiver is connected.
 - Consult the dealer or an experienced radio/TV technician for help.
- This device complies with part 15 of the FCC Rules. Operation is subject to the following two conditions: (1) This device may not cause harmful interference, and (2) this device must accept any interference received, including interference that may cause undesired operation.

Caution

Any changes or modifications not expressly approved by the party responsible for compliance could void the user's authority to operate the equipment.

Radiation Exposure Statement

This equipment complies with FCC radiation exposure limits set forth for an uncontrolled environment. This transmitter must not be co-located or operating in conjunction with any other antenna or transmitter. This equipment should be installed and operated with minimum distance 20cm between the radiator & your body.

Manufacturer: ZIONCOM ELECTRONICS (SHENZHEN) LTD.
Address: Room 702, Unit D, 4 Building Shenzhen Software Industry Base, Xuefu Road, Nanshan District, Shenzhen, Guangdong, China